

Recommended Standard Specification For Synthetic Web Slings

WSTDA-WS-1



©2004 Web Sling & Tie Down Association

This Standard is available through the WSTDA. Reproduction is not permitted

\$25.00

This Recommended Standard Specification has been formulated as a guide to users, industry and government to ensure the proper use, maintenance and inspection of synthetic web slings. The existence of this Recommended Standard Specification does not prevent members of the Web Sling and Tie Down Association or other manufacturers from manufacturing or selling products beyond the scope of this Recommended Standard Specification.

© Web Sling & Tie Down Association. All rights reserved. No part of this publication may be produced, stored in a retrieval system, or transmitted, in any form or by any means, electronic, mechanical, photocopying, recording or otherwise, without the prior permission of the Web Sling & Tie Down Association. This publication is circulated subject to the condition that it shall not, by way of trade or otherwise, be lent, sold, hired out or otherwise circulated without WSTDA's prior consent.

This Standard is available through the WSTDA. Reproduction is not permitted

FOREWORD

This Recommended Standard Specification applies to synthetic web slings. These slings are used for general lifting* purposes. This standard recommends construction, identification and marking of these slings. In addition, it gives rated capacity(s) (working load limit(s)) and important practical advice on the use, maintenance and inspection of these slings.

* *Lifting includes: raising, lowering or suspending*

The exclusion from this Recommended Standard Specification of web slings of different synthetic materials and capacities is not intended to preclude their use and shall not be interpreted in this manner. Disposable, or one time use, flat web slings for pre-slung unitized loads are not a subject of this standard.

Web slings made from materials or construction other than those detailed in this Recommended Standard Specification shall be used in accordance with the recommendations of the web sling manufacturer or qualified person. The specifications contained in this Recommended Standard Specification for Synthetic Web Slings were formulated under the auspices of the Web Sling & Tie Down Association, Inc. This Recommended Standard Specification is intended to assist users in specifying the proper synthetic web sling for their needs. To serve as a guide to the industry in the construction and use of synthetic web slings, and to serve as a guide to governmental and other regulatory bodies responsible for the proper use and inspection of synthetic web slings.

Safety is the paramount consideration involved in the use of any web sling. This standard does not purport to address all safety concerns, if any, associated with its use. It is the responsibility of the user of this standard to establish appropriate safety and health practices and determine the applicability of the regulatory limitations prior to use. The appropriate web sling shall be selected for the specific lift. Users of web slings shall have knowledge on the proper method of lifting item(s), and how they will react under normal and emergency situations. Also, users shall be knowledgeable about industry, local, state, federal and provincial regulations applicable to the item(s) being lifted.

MANDATORY AND ADVISORY RULES

**Mandatory rules of this standard are characterized by the word “shall.”
If a rule is of the advisory nature, it is indicated by the word “should,”
or is stated as a recommendation.**

WEB SLING & TIE DOWN ASSOCIATION, INC.

2105 Laurel Bush Road, Suite 200
Bel Air, MD 21015

Phone: (443) 640-1070
Fax: (443) 640-1031
Email: wstda@ksgroup.org
Website: www.wstda.com

First Published and Copyright 1978
First Revision 1983
Second Revision 1988
Third Revision 1994
Fourth Revision 2004

CONTENTS

CHAPTER 1.0 TERMINOLOGY & DEFINITIONS of WEB SLINGS	
Section 1.1 Purpose.....	1
Section 1.2 Description.....	1
Section 1.3 Basic Sling Types	1
Section 1.4 Bridle Slings (Multi-legged).....	2
Section 1.5 Other Sling Types	2
Section 1.6 Definitions of Terms	2
CHAPTER 2.0 CONSTRUCTION of WEB SLINGS	
Section 2.1 Purpose.....	7
Section 2.2 Webbing.....	7
Section 2.3 Thread	7
Section 2.4 Stitching	7
Section 2.5 Fittings	8
Section 2.6 Loop Eyes	8
Section 2.7 Coatings	9
Section 2.8 Design Factor.....	9
Section 2.9 Sling Identification/Marking Requirements	9
Section 2.10 Rated Capacities.....	9
CHAPTER 3.0 STANDARD PROCEDURES for TESTING WEB SLINGS	
Section 3.1 Purpose.....	23
Section 3.2 Types of Tests.....	23
Section 3.3 Test Characteristics	24
Section 3.4 Test Procedures	25
Section 3.5 Certification	26
CHAPTER 4.0 IDENTIFICATION/MARKING REQUIREMENTS	
Section 4.1 Purpose.....	26
Section 4.2 Identification of Fiber Types	26
Section 4.3 Identification of Synthetic Sling Webbing Manufacturer.....	27
Section 4.4 Identification of Web Sling Manufacturer.....	27
Section 4.5 Identification of Synthetic Webbing Class	27
CHAPTER 5.0 RECOMMENDED OPERATING PRACTICES for WEB SLINGS	
Section 5.1 Purpose.....	27
Section 5.2 Mechanical Considerations.....	27
Section 5.3 Environmental Considerations.....	29
Section 5.4 Inspection.....	30
Section 5.5 Removal From Service	31
Section 5.6 Inspection Records.....	31
Section 5.7 Repair of Web Slings	31
TABLES	
Loop Eye Table.....	8
Class 5 - 1 Ply Slings (Tables 1A & 1B) U.S.S. Inch-Pound units	10
Class 5 - 1 Ply Slings (Tables 2A & 2B) SI-Units	11
Class 5 - 2 Ply Slings (Tables 3A & 3B) U.S.S. Inch-Pound units	12
Class 5 - 2 Ply Slings (Tables 4A & 4B) SI-Units	13
Class 7 - 1 Ply Slings (Tables 5A & 5B) U.S.S. Inch-Pound units	14
Class 7 - 1 Ply Slings (Tables 6A & 6B) SI-Units	15
Class 7 - 2 Ply Slings (Tables 7A & 7B) U.S.S. Inch-Pound units	16
Class 7 - 2 Ply Slings (Tables 8A & 8B) SI-Units	17
Class 7 - 4 Ply Slings (Tables 9A & 9B) U.S.S. Inch-Pound units	18
Class 7 - 4 Ply Slings (Tables 10A & 10B) SI-Units	19
Sling Angle Table	21
Rated Capacity of Choker Hitch.....	22
Test Pin Table	25

CHAPTER 1.0 TERMINOLOGY AND DEFINITIONS OF WEB SLINGS

Section 1.1 PURPOSE

- 1.1.1 This chapter provides a description of synthetic web sling types and definitions, which apply to such slings.

Section 1.2 DESCRIPTION

- 1.2.1 A synthetic web sling is fabricated by sewing woven synthetic webbing of nylon or polyester type yarns, for the purpose of hoisting, lifting, and general material handling in basic sling types as illustrated in 1.3 “basic sling types”.

Section 1.3 BASIC SLING TYPES

- 1.3.1 TYPE I - Web sling made with a triangle fitting on one end and a slotted triangle choker fitting on the other end. It can be used in a vertical, basket or choker hitch. (See figure 1)

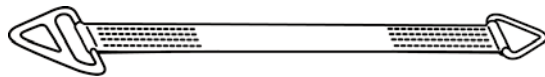

Figure 1

- 1.3.2 TYPE II - Web sling made with a triangle fitting on both ends. It can be used in a vertical or basket hitch only. (See figure 2)

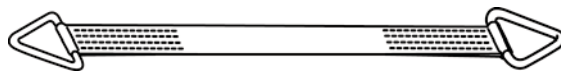

Figure 2

- 1.3.3 TYPE III - Web sling made with a flat loop eye on each end with loop eye opening on same plane as sling body. This type of sling is sometimes called a flat eye and eye, eye and eye, or double eye sling. (See figure 3)

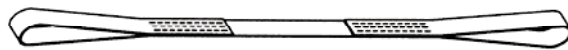

Figure 3

- 1.3.4 TYPE IV - Web Sling made with both loop eyes formed as in Type III, except that the loop eyes are turned to form a loop eye, which is at a right angle to the plane of the sling body. This type of sling is commonly referred to as a twisted eye sling. (See figure 4)

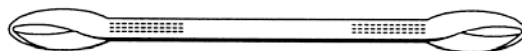

Figure 4

- 1.3.5 TYPE V - Endless web sling, sometimes referred to as a grommet. It is a continuous loop formed by joining the ends of the webbing together with a load-bearing splice. (See figure 5)



Figure 5

- 1.3.6 TYPE VI - Return eye (reversed eye) web sling is formed by using multiple widths of webbing held edge to edge. A wear pad is attached on one or both sides of the web sling body, and on one or both sides of the loop eyes to form a loop eye at each end, which is at a right angle to the plane of the web sling body (See figure 6)

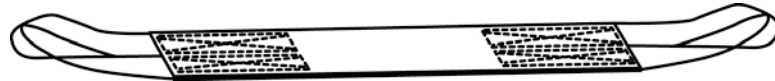

Figure 6

Section 1.4 BRIDLE SLINGS (MULTI-LEGGED)

- 1.4.1 A web sling with multiple legs. (See figure 7)

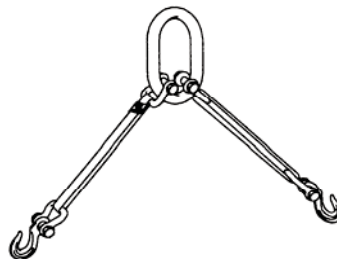

Figure 7

Section 1.5 OTHER SLING TYPES

- 1.5.1 Other sling types are available and shall be used in accordance with web sling manufacturer or qualified person's recommendation.

Section 1.6 DEFINITIONS OF TERMS

Abrasion - The mechanical wearing of a surface resulting from frictional contact with other materials.

Body - That part of a web sling which is between the end fittings or loop eyes. (See figure 8)

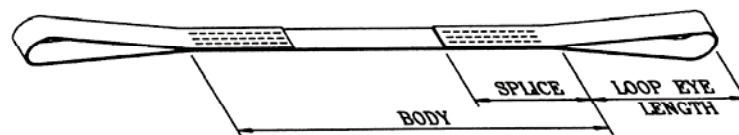

Figure 8

Breaking Strength - That load in pounds or kilograms at which point any load bearing part of the sling fails.

Coating - A finish applied to the webbing for a special purpose.

Design Factor - The ratio of the breaking strength to the “rated capacity” for each new web sling.

Designated Person - Selected or assigned by the employer or employers’ representative as being competent to perform specific duties.

Elongation - The measurement of stretch, at a given load, expressed as a percentage of the original unloaded length.

Fabrication Efficiency - The ratio of a web sling assembly strength to webbing strength prior to fabrication, expressed as a percentage.

Fitting - A load-bearing device, which is attached to the web sling.

Hitch/Vertical - A method of rigging a sling in which the load is attached to the loop eye or end fitting at one end of the sling and the loop eye or end fitting at the other end is attached to the lifting device. (See figure 9)

Hitch/Choker - A method of rigging a sling in which the sling is passed around the load, then through one loop eye, end fitting, or device with the other loop eye or end fitting attached to the lifting device. This hitch can be done with a sliding choker hook or similar device. (See figure 9)

Hitch/Vertical Basket- A method of rigging a sling in which the sling is passed around the load and both loop eyes or end fittings are attached to the lifting device. (See figure 9)

Hitch/Angled Basket-Same as Basket Vertical hitch except that the attachment point of the lifting device (over the load) forces an angled hitch. (See figure 9)

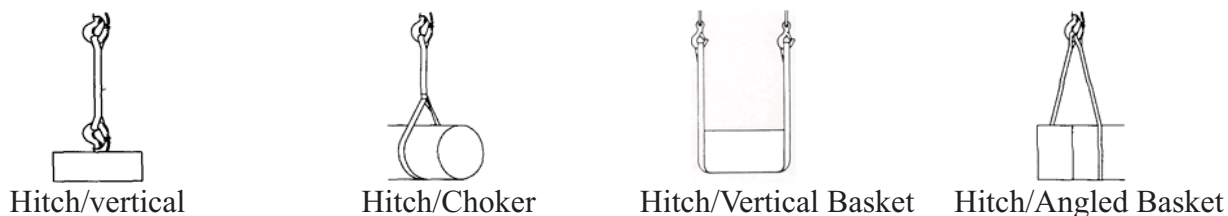

Figure 9

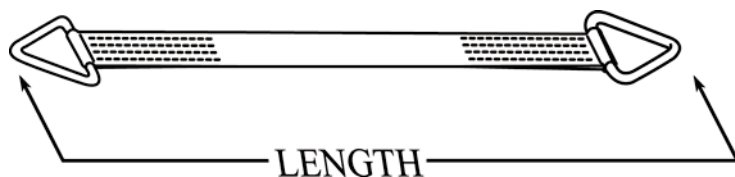

Figure 10

Length (reach) - The distance between the extreme and bearing points of the web sling, including fittings if applicable. (See figure 10)

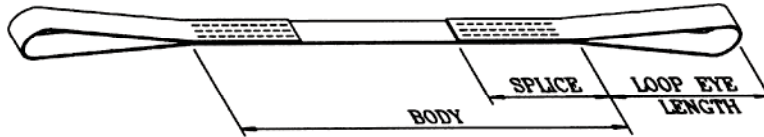

Figure 11

Loop Eye - A length of webbing which has been folded back upon itself, forming an opening, and joined to the web sling body to form a bearing surface. (See figure 11)

Breaking Strength - Minimum load at which a new web sling or component will break when loaded to destruction in direct tension.

Plies - The number of thicknesses of load bearing webbing used in the web sling assembly. (See

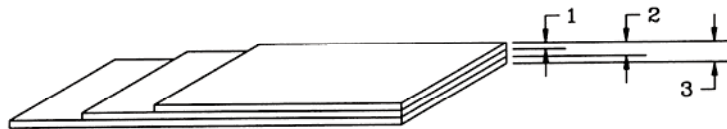

Figure 12

figure 12)

Proof Load Test - A non-destructive load test of the web sling to some multiple of the rated capacity of that web sling, including fittings if applicable. (Usually two (2) times the rated capacity).

Qualified Person - A person who by possession of a recognized degree or certificate of professional standing or who by extensive knowledge, training, and experience has successfully demonstrated the ability to solve or resolve problems related to the subject matter and work.

Rated Capacity (Working Load Limit) - The maximum allowable load for each web sling assembly for the type of hitch used.

Selvedge - The woven or knitted with lockstitch edge of webbing formed to prevent raveling.

Shock Loading - An unintended condition of rapid lift, sudden shifting of load, or arrest of a falling load that causes the forces in a sling to notably exceed that which would have occurred under normal loading conditions. This increase in force due to a high rate of loading may be caused by inertia effects, changes in the properties of sling members, or both.

Splice - That part of a web sling which is lapped and secured to become an integral part of the web sling. Types of splices are as follows:

a. Load Bearing Splice - Any splice that carries a portion of the total load applied. (See figure 13)

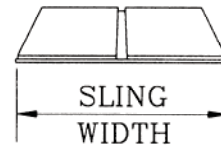

Figure 13

b. Assembly Splice - Any splice that joins two or more parts of the sling without bearing any of the applied load. (See figure 14)



(Two or more widths of web joined side by side with a narrower width of web)



(Two or more widths of web joined side by side with a full width of web)

Figure 14

Stitch Pattern Failure (Lap pulled apart) - Separation of the load-bearing splice due to thread failure.

Synthetic Fiber - Man-made fibers.

Synthetic Web Sling - A lifting assembly made of synthetic webbing which is to be used to connect the load to the lifting device.

Tapered Eye - A loop eye which is formed by folding the webbing to a narrower width at its bearing point to accommodate the lifting device, a tapered eye may be either flat (Type III) or twisted (Type IV). (See figure 15)

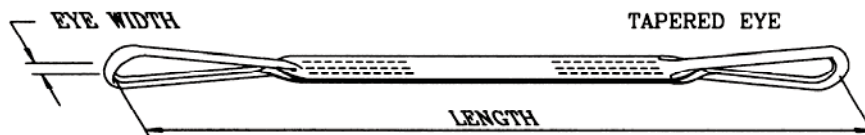

Figure 15

Thickness - The depth of the sling, as opposed to the width or length.

Thread - The synthetic yarn, which is used to sew the web sling together.

Triangle Fitting - An end attachment which is used for connecting the web sling to the lifting device. (See figure 16)

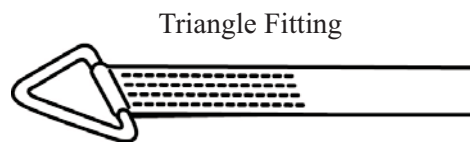

Figure 16

Triangle Choker Fitting - Similar to the “triangle fitting” except that it also has a slot through which the “triangle fitting” can be passed through in order to permit a “choker hitch” on the load. (See figure 17)

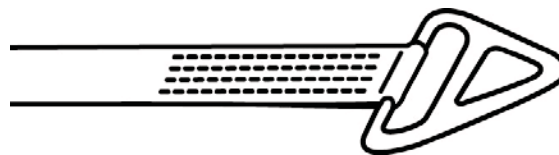

Figure 17

Wear Pad - Leather, webbing or other fixed or sliding material used to protect the web sling from being damaged.

a. Fixed Wear Pad (See figure 18)

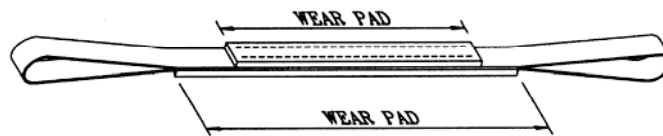

Figure 18

b. Sliding Wear Pad (See figure 19)

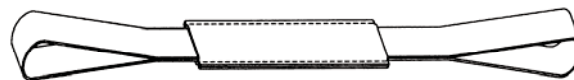

Figure 19

Webbing - A fabric woven of high tenacity synthetic yarns offering suitable characteristics for use in the manufacture of web slings.

Webbing Strength Rating - The minimum strength of webbing, expressed in pounds per inch (or kilograms per millimeters) of webbing width.

Width - The distance across the web sling body from outer selvedge to outer selvedge.
(See figure 20)

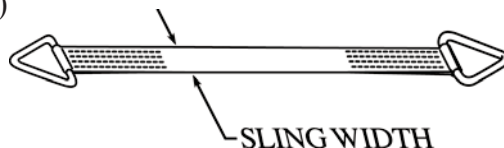

Figure 20

Working Load Limit - See rated capacity.

Yarn - The synthetic fibers used to make the webbing and thread.

CHAPTER 2.0 CONSTRUCTION OF WEB SLINGS

Section 2.1 PURPOSE

2.1.1 This chapter provides an outline of materials and construction characteristics of synthetic web slings.

Section 2.2 WEBBING

2.2.1 The webbing shall be certifiable to tensile strength, have uniform thickness and width, and have selvedges.

2.2.2 Webbing shall be woven from a synthetic yarn that is heat and light resistant

2.2.3 All webbing ends shall be sealed by heater other suitable means to prevent raveling.

2.2.4 The webbing can be manufactured on either a shuttle loom or shuttle-less loom. When shuttle-less loom construction is utilized the filling yarn shall traverse the full width of the webbing and shall be held at the knitted edge by a catch cord interlacing with filling yarn.

2.2.5 Class 5 webbing, either loom state or treated, shall have a minimum breaking strength of 6800 pounds per inch of width/ 121.43 kilograms per millimeter of width. Class 7 webbing, either loom state or treated, shall have a minimum breaking strength of 9800 pounds per inch of width / 175 kilograms per millimeter of width.

Section 2.3 THREAD

2.3.1 The thread used in the manufacture of synthetic web slings shall be of the same type synthetic yarn as the sling webbing.

2.3.2 For in-depth information about thread please refer to WSTDA-TH-1

Section 2.4 STITCHING

2.4.1 The stitch pattern and length of stitching shall be in accordance with the manufacturers' standard practice.

2.4.2 The stitching in all load-bearing splices of new web slings shall be of sufficient strength to achieve a minimum design factor of five (5).

2.4.3 All stitches shall be lock-stitched and preferably continuous. When not continuous, they shall be backstitched at the ends to prevent raveling.

Section 2.5 FITTINGS

WARNING: THE USE OF IMPROPER FITTINGS AND/OR MATERIALS MAY RESULT IN SEVERE PERSONAL INJURY OR DEATH.

- 2.5.1 This section relates to fittings of metal or other suitable materials which may be attached to the web sling for the purpose of engaging a lifting device. The fittings may be a permanent or detachable part of the web sling.
- 2.5.1.1 **Material** - The material selected shall be compatible with the mechanical and environmental requirements imposed on the fitting.
- 2.5.1.2 **Finish** - All surfaces shall be cleanly finished and edges shall have sufficient radii to prevent cutting of webbing.
- 2.5.1.3 **Design Criteria** - Fittings shall have a minimum design factor of five (5) and have sufficient strength to sustain twice the rated capacity load without permanent deformation.
- 2.5.1.4 **Reuse of Fittings** - Fittings shall be inspected prior to reuse. Fittings shall not be reused if excessive wear, pitting, corrosion, cracks, distortion and/or breaks are visible. (See 2.5.1.5)
- 2.5.1.5 **Proof Test** - Web sling assemblies incorporating reused or welded fittings shall be proof tested to a minimum of two (2) times the rated capacity.

Section 2.6 LOOP EYES

- 2.6.1 Recommended minimum loop eye length and suggested loop eye width for types III, IV and VI web slings are listed in the following tables. See Section 1.3, Basic Sling Types.

Loop Eye Table - 1 & 2 Ply Slings

Sling Web Width	Recommended Min. Loop Eye Length	Suggested Loop Eye Width
1" (25 mm)	6" (152 mm)	1" (25 mm)
1½" (38 mm)	6" (152 mm)	1½" (38 mm)
1¾" (44 mm)	6" (152 mm)	1¾" (44 mm)
2" (51 mm)	8" (204 mm)	2" (51 mm)
3" (76 mm)	10" (254 mm)	1½" (38 mm)
4" (102 mm)	12" (304 mm)	1½" (38 mm)
5" (127 mm)	12" (304 mm)	1¾" (44 mm)
6" (152 mm)	14" (355 mm)	2" (51 mm)
8" (204 mm)	18" (457 mm)	3" (76 mm)
10" (254 mm)	22" (560 mm)	4" (102 mm)
12" (304 mm)	26" (660 mm)	5" (127 mm)

Section 2.7 COATINGS

- 2.7.1 Web slings may be coated with suitable materials that will impart desirable characteristics, such as:
- Abrasion resistance
 - Sealing to prevent penetration of foreign particles and matter
 - Increased coefficient of friction
 - Ultra-violet light resistance

Section 2.8 DESIGN FACTOR

- 2.8.1 The design factor for new synthetic web slings with or without fittings shall be a minimum of five (5) when tested in accordance with Section 3.

Section 2.9 IDENTIFICATION/MARKING REQUIREMENTS

- 2.9.1 The manufacturer shall attach web sling identification tag (s) to the sling. The identification tag shall show the following information:
- Name or trademark of manufacturer
 - Manufacturer's code or stock number
 - Rated capacities for types of hitches, and the angle upon which it is based
 - Type of synthetic web yarn

Section 2.10 RATED CAPACITIES

- 2.10.1 Single ply web slings fall into the classification shown in Tables 1A, 1B, 2A, 2B, 5A, 5B, 6A and 6B. Two (2) ply web slings fall into the classification shown in Tables 3A, 3B, 4A, 4B, 7A, 7B, 8A and 8B. Four (4) ply web slings fall into the classification shown in Tables 9A, 9B, 10A and 10B. A web sling shall not be used at a load greater than that shown in the appropriate table or on its sling identification. Web slings not included in these tables shall be used in accordance with the manufacturer's recommendations.
- 2.10.2 Each manufacturer shall retain test data to verify the minimum breaking strengths. Destructive tests shall be conducted according to the test procedure outlined in Section 3.
- 2.10.3 **Rated Capacity Determination** - The formula for determining the rated capacity of a new web sling is as follows:

$$RC = \frac{CTS \times FE}{5}$$

Where:

RC	=	Rated Capacity
CTS	=	Certified Tensile Strength of Webbing
FE	=	Fabrication Efficiency
5	=	Design Factor of 5

- 2.10.4 The choker hitch capacity shall be rated at a maximum of 80% of the vertical capacity.
- 2.10.5 The vertical basket hitch capacity shall be rated at a maximum of two (2) times the vertical capacity.

RATED CAPACITY TABLES

RATED CAPACITY FOR SYNTHETIC WEB SLINGS

TABLE 1A
U.S.S. Inch-Pound units - Class 5 - 1 Ply Slings
 Types I, II, III, IV













Sling Width, Inches	SINGLE LEG			2 LEG OR SINGLE BASKET			
	HITCH TYPES			HORIZONTAL ANGLES			
	Vertical	Choker	Vertical Basket	Vertical	60°	45°	30°
							
1 in.	1,100 lb.	880 lb.	2,200 lb.	2,200 lb.	1,905 lb.	1,555 lb.	1,100 lb.
1 ½ in.	1,600 lb.	1,280 lb.	3,200 lb.	3,200 lb.	2,771 lb.	2,262 lb.	1,600 lb.
1 ¾ in.	1,900 lb.	1,520 lb.	3,800 lb.	3,800 lb.	3,291 lb.	2,687 lb.	1,900 lb.
2 in.	2,200 lb.	1,760 lb.	4,400 lb.	4,400 lb.	3,810 lb.	3,111 lb.	2,200 lb.
3 in.	3,300 lb.	2,640 lb.	6,600 lb.	6,600 lb.	5,716 lb.	4,666 lb.	3,300 lb.
4 in.	4,400 lb.	3,520 lb.	8,800 lb.	8,800 lb.	7,621 lb.	6,222 lb.	4,400 lb.
5 in.	5,500 lb.	4,400 lb.	11,000 lb.	11,000 lb.	9,526 lb.	7,777 lb.	5,500 lb.
6 in.	6,600 lb.	5,280 lb.	13,200 lb.	13,200 lb.	11,431 lb.	9,332 lb.	6,600 lb.

TABLE 1B
U.S.S. Inch-Pound units - Class 5 - 1 Ply Slings
 Type V

Sling Width, Inches	HITCH TYPES			HORIZONTAL ANGLES		
	Endless Vertical	Choker	Vertical Basket	60°	45°	30°
						
1 in.	2,200 lb.	1,760 lb.	4,400 lb.	3,810 lb.	3,111 lb.	2,200 lb.
1 ½ in.	3,200 lb.	2,560 lb.	6,400 lb.	5,542 lb.	4,525 lb.	3,200 lb.
1 ¾ in.	3,800 lb.	3,040 lb.	7,600 lb.	6,582 lb.	5,373 lb.	3,800 lb.
2 in.	4,400 lb.	3,520 lb.	8,800 lb.	7,621 lb.	6,222 lb.	4,400 lb.
3 in.	6,600 lb.	5,280 lb.	13,200 lb.	11,431 lb.	9,332 lb.	6,600 lb.
4 in.	8,800 lb.	7,040 lb.	17,600 lb.	15,242 lb.	12,443 lb.	8,800 lb.
5 in.	11,000 lb.	8,800 lb.	22,000 lb.	19,052 lb.	15,554 lb.	11,000 lb.
6 in.	13,200 lb.	10,560 lb.	26,400 lb.	22,862 lb.	18,665 lb.	13,200 lb.

Notes:

- 1) The rated capacities are based on stuffer weave construction webbing with a minimum certified tensile strength of 6800 pounds per inch of webbing width.
- 2) Rated capacities for Type III and IV slings apply to both tapered and non-tapered eye constructions. Rated capacities for Type V slings are based on non-tapered webbing.
- 3) For Type VI slings, consult the manufacturer for rated capacities.

RATED CAPACITY FOR SYNTHETIC WEB SLINGS

TABLE 2A
SI-Units - Class 5 - 1 Ply Slings
 Types I, II, III, IV













Sling Width, Mms	SINGLE LEG			2 LEG OR SINGLE BASKET			
	HITCH TYPES			HORIZONTAL ANGLES			
	Vertical	Choker	Vertical Basket	Vertical	60°	45°	30°
							
25 mm	500 kg.	400 kg.	1,000 kg.	1,000 kg.	866 kg.	707 kg.	500 kg.
38 mm	725 kg.	580 kg.	1,450 kg.	1,450 kg.	1,256 kg.	1,025 kg.	725 kg.
44 mm	850 kg.	680 kg.	1,700 kg.	1,700 kg.	1,472 kg.	1,202 kg.	850 kg.
51 mm	1,000 kg.	800 kg.	2,000 kg.	2,000 kg.	1,732 kg.	1,414 kg.	1,000 kg.
76 mm	1,500 kg.	1,200 kg.	3,000 kg.	3,000 kg.	2,598 kg.	2,121 kg.	1,500 kg.
102 mm	2,000 kg.	1,600 kg.	4,000 kg.	4,000 kg.	3,464 kg.	2,828 kg.	2,000 kg.
127 mm	2,500 kg.	2,000 kg.	5,000 kg.	5,000 kg.	4,330 kg.	3,535 kg.	2,500 kg.
152 mm	3,000 kg.	2,400 kg.	6,000 kg.	6,000 kg.	5,196 kg.	4,242 kg.	3,000 kg.

TABLE 2B
SI-Units - Class 5 - 1 Ply Slings
 Type V

Sling Width, Mms	HITCH TYPES			ORIZONTAL ANGLES		
	Endless Vertical	Choker	Vertical Basket	60°	45°	30°
						
25 mm	1,000 kg.	800 kg.	2,000 kg.	1,732 kg.	1,414 kg.	1,000 kg.
38 mm	1,450 kg.	1,160 kg.	2,900 kg.	2,511 kg.	2,050 kg.	1,450 kg.
44 mm	1,700 kg.	1,360 kg.	3,400 kg.	2,944 kg.	2,404 kg.	1,700 kg.
51 mm	2,000 kg.	1,600 kg.	4,000 kg.	3,464 kg.	2,828 kg.	2,000 kg.
76 mm	3,000 kg.	2,400 kg.	6,000 kg.	5,196 kg.	4,242 kg.	3,000 kg.
102 mm	4,000 kg.	3,200 kg.	8,000 kg.	6,928 kg.	5,656 kg.	4,000 kg.
127 mm	5,000 kg.	4,000 kg.	10,000 kg.	8,660 kg.	7,070 kg.	5,000 kg.
152 mm	6,000 kg.	4,800 kg.	12,000 kg.	10,392 kg.	8,484 kg.	6,000 kg.

Notes:

- 1) The rated capacities are based on stuffer weave construction webbing with a minimum certified tensile strength of 121.43 kilograms per millimeter of webbing width.
- 2) Rated capacities for Type III and IV slings apply to both tapered and non-tapered eye constructions. Rated capacities for Type V slings are based on non-tapered webbing.
- 3) For Type VI slings, consult the manufacturer for rated capacities.

RATED CAPACITY FOR SYNTHETIC WEB SLINGS

TABLE 3A
U.S.S. Inch-Pound Units - Class 5 - 2 Ply Slings
 Types I, II, III, IV













Sling Width, Inches	SINGLE LEG			2 LEG OR SINGLE BASKET			
	HITCH TYPES			HORIZONTAL ANGLES			
	Vertical	Choker	Vertical Basket	Vertical	60°	45°	30°
							
1 in.	2,200 lb.	1,760 lb.	4,400 lb.	4,400 lb.	3,810 lb.	3,111 lb.	2,200 lb.
1 ½ in.	3,300 lb.	2,640 lb.	6,600 lb.	6,600 lb.	5,716 lb.	4,666 lb.	3,300 lb.
1 ¾ in.	3,800 lb.	3,040 lb.	7,600 lb.	7,600 lb.	6,582 lb.	5,373 lb.	3,800 lb.
2 in.	4,400 lb.	3,520 lb.	8,800 lb.	8,800 lb.	7,621 lb.	6,222 lb.	4,400 lb.
3 in.	6,600 lb.	5,280 lb.	13,200 lb.	13,200 lb.	11,431 lb.	9,332 lb.	6,600 lb.
4 in.	8,200 lb.	6,560 lb.	16,400 lb.	16,400 lb.	14,202 lb.	11,595 lb.	8,200 lb.
5 in.	10,200 lb.	8,160 lb.	20,400 lb.	20,400 lb.	17,666 lb.	14,423 lb.	10,200 lb.
6 in.	12,300 lb.	9,840 lb.	24,600 lb.	24,600 lb.	21,304 lb.	17,392 lb.	12,300 lb.

TABLE 3B
U.S.S. Inch-Pound Units - Class 5 - 2 Ply Slings
 Type V

Sling Width, Inches	HITCH TYPES			HORIZONTAL ANGLES		
	Endless Vertical	Choker	Vertical Basket	60°	45°	30°
						
1 in.	4,400 lb.	3,520 lb.	8,800 lb.	7,621 lb.	6,222 lb.	4,400 lb.
1 ½ in.	6,600 lb.	5,280 lb.	13,200 lb.	11,431 lb.	9,332 lb.	6,600 lb.
1 ¾ in.	7,600 lb.	6,080 lb.	15,200 lb.	13,163 lb.	10,746 lb.	7,600 lb.
2 in.	8,800 lb.	7,040 lb.	17,600 lb.	15,242 lb.	12,443 lb.	8,800 lb.
3 in.	13,200 lb.	10,560 lb.	26,400 lb.	22,862 lb.	18,665 lb.	13,200 lb.
4 in.	16,400 lb.	13,120 lb.	32,800 lb.	28,405 lb.	23,190 lb.	16,400 lb.
5 in.	20,400 lb.	16,320 lb.	40,800 lb.	35,333 lb.	28,846 lb.	20,400 lb.
6 in.	24,600 lb.	19,680 lb.	49,200 lb.	42,607 lb.	34,784 lb.	24,600 lb.

Notes:

- 1) The rated capacities are based on stuffer weave construction webbing with a minimum certified tensile strength of 6800 pounds per inch of webbing width.
- 2) Rated capacities for Type III and IV slings apply to both tapered and non-tapered eye constructions. Rated capacities for Type V slings are based on non-tapered webbing.
- 3) For Type VI slings, consult the manufacturer for rated capacities.

RATED CAPACITY FOR SYNTHETIC WEB SLINGS

TABLE 4A
SI-Units - Class 5 - 2 Ply Slings
 Types I, II, III, IV













Sling Width, Mms	SINGLE LEG			2 LEG OR SINGLE BASKET			
	HITCH TYPES			HORIZONTAL ANGLES			
	Vertical	Choker	Vertical Basket	Vertical	60°	45°	30°
							
25 mm	1,000 kg.	800 kg.	2,000 kg.	2,000 kg.	1,732 kg.	1,414 kg.	1,000 lb.
38 mm	1,500 kg.	1,200 kg.	3,000 kg.	3,000 kg.	2,598 kg.	2,121 kg.	1,500 kg.
44 mm	1,700 kg.	1,360 kg.	3,400 kg.	3,400 kg.	2,944 kg.	2,404 kg.	1,700 kg.
51 mm	2,000 kg.	1,600 kg.	4,000 kg.	4,000 kg.	3,464 kg.	2,828 kg.	2,000 kg.
76 mm	3,000 kg.	2,400 kg.	6,000 kg.	6,000 kg.	5,196 kg.	4,242 kg.	3,000 kg.
102 mm	3,700 kg.	2,960 kg.	7,400 kg.	7,400 kg.	6,408 kg.	5,232 kg.	3,700 kg.
127mm	4,650 kg.	3,720 kg.	9,300 kg.	9,300 kg.	8,054 kg.	6,575 kg.	4,650 kg.
152 mm	5,600 kg.	4,480 kg.	11,200 kg.	11,200 kg.	9,699 kg.	7,918 kg.	5,600 kg.

TABLE 4B
SI-Units - Class 5 - 2 Ply Slings
 Type V

Sling Width, Mms	HITCH TYPES			HORIZONTAL ANGLES		
	Endless Vertical	Choker	Vertical Basket	60°	45°	30°
						
25 mm	2,000 kg.	1,600 kg.	4,000 kg.	3,464 kg.	2,828 kg.	2,000 kg.
38 mm	3,000 kg.	2,400 kg.	6,000 kg.	5,196 kg.	4,242 kg.	3,000 kg.
44 mm	3,450 kg.	2,760 kg.	6,900 kg.	5,975 kg.	4,878 kg.	3,450 kg.
51 mm	4,000 kg.	3,200 kg.	8,000 kg.	6,928 kg.	5,656 kg.	4,000 kg.
76 mm	6,000 kg.	4,800 kg.	12,000 kg.	10,392 kg.	8,484 kg.	6,000 kg.
102 mm	7,450 kg.	5,960 kg.	14,900 kg.	12,903 kg.	10,534 kg.	7,450 kg.
127mm	9,250 kg.	7,400 kg.	18,500 kg.	16,021 kg.	13,080 kg.	9,250 kg.
152 mm	11,150 kg.	8,920 kg.	22,300 kg.	19,312 kg.	15,766 kg.	11,150 kg.

Notes:

- 1) The rated capacities are based on stuffer weave construction webbing with a minimum certified tensile strength of 121.43 kilograms per millimeter of webbing width.
- 2) Rated capacities for Type III and IV slings apply to both tapered and non-tapered eye constructions. Rated capacities for Type V slings are based on non-tapered webbing.
- 3) For Type VI slings, consult the manufacturer for rated capacities.

RATED CAPACITY FOR SYNTHETIC WEB SLINGS

TABLE 5A
U.S.S. Inch-Pound units - Class 7 - 1 Ply Slings
 Types I, II, III, IV













Sling Width, Inches	SINGLE LEG			2 LEG OR SINGLE BASKET			
	HITCH TYPES			HORIZONTAL ANGLES			
	Vertical	Choker	Vertical Basket	Vertical	60°	45°	30°
							
1 in.	1,600 lb.	1,280 lb.	3,200 lb.	3,200 lb.	2,771 lb.	2,262 lb.	1,600 lb.
1 ½ in.	2,300 lb.	1,840 lb.	4,600 lb.	4,600 lb.	3,984 lb.	3,252 lb.	2,300 lb.
1 ¾ in.	2,700 lb.	2,160 lb.	5,400 lb.	5,400 lb.	4,676 lb.	3,818 lb.	2,700 lb.
2 in.	3,100 lb.	2,480 lb.	6,200 lb.	6,200 lb.	5,369 lb.	4,383 lb.	3,100 lb.
3 in.	4,700 lb.	3,760 lb.	9,400 lb.	9,400 lb.	8,140 lb.	6,646 lb.	4,700 lb.
4 in.	6,200 lb.	4,960 lb.	12,400 lb.	12,400 lb.	10,738 lb.	8,767 lb.	6,200 lb.
5 in.	7,800 lb.	6,240 lb.	15,600 lb.	15,600 lb.	13,510 lb.	11,029 lb.	7,800 lb.
6 in.	9,300 lb.	7,440 lb.	18,600 lb.	18,600 lb.	16,108 lb.	13,150 lb.	9,300 lb.
8 in.	11,800 lb.	9,440 lb.	23,600 lb.	23,600 lb.	20,438 lb.	16,685 lb.	11,800 lb.
10 in.	14,700 lb.	11,760 lb.	29,400 lb.	29,400 lb.	25,460 lb.	20,786 lb.	14,700 lb.
12 in.	17,600 lb.	14,080 lb.	35,200 lb.	35,200 lb.	30,483 lb.	24,886 lb.	17,600 lb.

TABLE 5B
U.S.S. Inch-Pound units - Class 7 - 1 Ply Slings
 Type V

Sling Width, Inches	HITCH TYPES			HORIZONTAL ANGLES		
	Endless Vertical	Choker	Vertical Basket	60°	45°	30°
						
1 in.	3,200 lb.	2,560 lb.	6,400 lb.	5,542 lb.	4,525 lb.	3,200 lb.
1 ½ in.	4,600 lb.	3,680 lb.	9,200 lb.	7,967 lb.	6,504 lb.	4,600 lb.
1 ¾ in.	5,400 lb.	4,320 lb.	10,800 lb.	9,353 lb.	7,636 lb.	5,400 lb.
2 in.	6,200 lb.	4,960 lb.	12,400 lb.	10,738 lb.	8,767 lb.	6,200 lb.
3 in.	9,400 lb.	7,520 lb.	18,800 lb.	16,281 lb.	13,292 lb.	9,400 lb.
4 in.	12,400 lb.	9,920 lb.	24,800 lb.	21,477 lb.	17,534 lb.	12,400 lb.
5 in.	15,600 lb.	12,480 lb.	31,200 lb.	27,019 lb.	22,058 lb.	15,600 lb.
6 in.	18,600 lb.	14,880 lb.	37,200 lb.	32,215 lb.	26,300 lb.	18,600 lb.
8 in.	21,200 lb.	16,960 lb.	42,400 lb.	36,718 lb.	29,977 lb.	21,200 lb.
10 in.	26,500 lb.	21,200 lb.	53,000 lb.	45,898 lb.	37,471 lb.	26,500 lb.
12 in.	31,800 lb.	25,440 lb.	63,600 lb.	55,078 lb.	44,965 lb.	31,800 lb.

Notes:

- 1) The rated capacities are based on stuffer weave construction webbing with a minimum certified tensile strength of 9800 pounds per inch of webbing width.
- 2) Rated capacities for Type III and IV slings apply to both tapered and non-tapered eye constructions. Rated capacities for Type V slings are based on non-tapered webbing.
- 3) For Type VI slings, consult the manufacturer for rated capacities.

RATED CAPACITY FOR SYNTHETIC WEB SLINGS

TABLE 6A
SI-Units - Class 7 - 1 Ply Slings
 Types I, II, III, IV













Sling Width, Mms	SINGLE LEG			2 LEG OR SINGLE BASKET			
	HITCH TYPES			HORIZONTAL ANGLES			
	Vertical	Choker	Vertical Basket	Vertical	60°	45°	30°
							
25 mm	725 kg.	580 kg.	1,450 kg.	1,450 kg.	1,256 kg.	1,025 kg.	725 kg.
38 mm	1,025 kg.	820 kg.	2,050 kg.	2,050 kg.	1,775 kg.	1,449 kg.	1,025 kg.
44 mm	1,225 kg.	980 kg.	2,450 kg.	2,450 kg.	2,122 kg.	1,732 kg.	1,225 kg.
51 mm	1,400 kg.	1,120 kg.	2,800 kg.	2,800 kg.	2,425 kg.	1,980 kg.	1,400 kg.
76 mm	2,125 kg.	1,700 kg.	4,250 kg.	4,250 kg.	3,681 kg.	3,005 kg.	2,125 kg.
102 mm	2,800 kg.	2,240 kg.	5,600 kg.	5,600 kg.	4,850 kg.	3,959 kg.	2,800 kg.
127 mm	3,500 kg.	2,800 kg.	7,000 kg.	7,000 kg.	6,062 kg.	4,949 kg.	3,500 kg.
152 mm	4,200 kg.	3,360 kg.	8,400 kg.	8,400 kg.	7,274 kg.	5,939 kg.	4,200 kg.
203 mm	5,350 kg.	4,280 kg.	10,700 kg.	10,700 kg.	9,266 kg.	7,565 kg.	5,350 kg.
254 mm	6,650 kg.	5,320 kg.	13,300 kg.	13,300 kg.	11,518 kg.	9,403 kg.	6,650 kg.
305 mm	8,000 kg.	6,400 kg.	16,000 kg.	16,000 kg.	13,856 kg.	11,312 kg.	8,000 kg.

TABLE 6B
SI-Units - Class 7 - 1 Ply Slings
 Type V

Sling Width, Mms	HITCH TYPES			HORIZONTAL ANGLES		
	Endless Vertical	Choker	Vertical Basket	60°	45°	30°
						
25 mm	1,450 kg.	1,160 kg.	2,900 kg.	2,511 kg.	2,050 kg.	1,450 kg.
38 mm	2,075 kg.	1,660 kg.	4,150 kg.	3,594 kg.	2,934 kg.	2,075 kg.
44 mm	2,450 kg.	1,960 kg.	4,900 kg.	4,243 kg.	3,464 kg.	2,450 kg.
51 mm	2,800 kg.	2,240 kg.	5,600 kg.	4,850 kg.	3,959 kg.	2,800 kg.
76 mm	4,225 kg.	3,380 kg.	8,450 kg.	7,318 kg.	5,974 kg.	4,225 kg.
102 mm	5,600 kg.	4,480 kg.	11,200 kg.	9,699 kg.	7,918 kg.	5,600 kg.
127 mm	7,050 kg.	5,640 kg.	14,100 kg.	12,211 kg.	9,969 kg.	7,050 kg.
152 mm	8,450 kg.	6,760 kg.	16,900 kg.	14,635 kg.	11,948 kg.	8,450 kg.
203 mm	9,600 kg.	7,680 kg.	19,200 kg.	16,627 kg.	13,574 kg.	9,600 kg.
254 mm	12,000 kg.	9,600 kg.	24,000 kg.	20,784 kg.	16,968 kg.	12,000 kg.
305 mm	14,400 kg.	11,520 kg.	28,800 kg.	24,941 kg.	20,362 kg.	14,400 kg.

Notes:

- 1) The rated capacities are based on stuffer weave construction webbing with a minimum certified tensile strength of 175 kilograms per millimeter of webbing width.
- 2) Rated capacities for Type III and IV slings apply to both tapered and non-tapered eye constructions. Rated capacities for Type V slings are based on non-tapered webbing.
- 3) For Type VI slings, consult the manufacturer for rated capacities.

RATED CAPACITY FOR SYNTHETIC WEB SLINGS

TABLE 7A
U.S.S. Inch-Pound units - Class 7 - 2 Ply Slings
Types I, II, III, IV













Sling Width, Inches	SINGLE LEG			2 LEG OR SINGLE BASKET			
	HITCH TYPES			HORIZONTAL ANGLES			
	Vertical	Choker	Vertical Basket	Vertical	60°	45°	30°
							
1 in.	3,100 lb.	2,480 lb.	6,200 lb.	6,200 lb.	5,369 lb.	4,383 lb.	3,100 lb.
1 ½ in.	4,700 lb.	3,760 lb.	9,400 lb.	9,400 lb.	8,140 lb.	6,646 lb.	4,700 lb.
1 ¾ in.	5,400 lb.	4,320 lb.	10,800 lb.	10,800 lb.	9,353 lb.	7,636 lb.	5,400 lb.
2 in.	6,200 lb.	4,960 lb.	12,400 lb.	12,400 lb.	10,738 lb.	8,767 lb.	6,200 lb.
3 in.	8,800 lb.	7,040 lb.	17,600 lb.	17,600 lb.	15,242 lb.	12,443 lb.	8,800 lb.
4 in.	11,000 lb.	8,800 lb.	22,000 lb.	22,000 lb.	19,052 lb.	15,554 lb.	11,000 lb.
5 in.	13,700 lb.	10,960 lb.	27,400 lb.	27,400 lb.	23,728 lb.	19,372 lb.	13,700 lb.
6 in.	16,500 lb.	13,200 lb.	33,000 lb.	33,000 lb.	28,578 lb.	23,331 lb.	16,500 lb.
8 in.	22,700 lb.	18,160 lb.	45,400 lb.	45,400 lb.	39,316 lb.	32,098 lb.	22,700 lb.
10 in.	28,400 lb.	22,720 lb.	56,800 lb.	56,800 lb.	49,189 lb.	40,158 lb.	28,400 lb.
12 in.	34,100 lb.	27,280 lb.	68,200 lb.	68,200 lb.	59,061 lb.	48,217 lb.	34,100 lb.

TABLE 7B
U.S.S. Inch-Pound units - Class 7 - 2 Ply Slings
Type V

Sling Width, Inches	HITCH TYPES			ORIZONTAL ANGLES		
	Endless Vertical	Choker	Vertical Basket	60°	45°	30°
						
1 in.	6,200 lb.	4,960 lb.	12,400 lb.	10,738 lb.	8,767 lb.	6,200 lb.
1 ½ in.	9,400 lb.	7,520 lb.	18,800 lb.	16,281 lb.	13,292 lb.	9,400 lb.
1 ¾ in.	10,800 lb.	8,640 lb.	21,600 lb.	18,706 lb.	15,271 lb.	10,800 lb.
2 in.	12,400 lb.	9,920 lb.	24,800 lb.	21,477 lb.	17,534 lb.	12,400 lb.
3 in.	17,600 lb.	14,080 lb.	35,200 lb.	30,483 lb.	24,886 lb.	17,600 lb.
4 in.	22,000 lb.	17,600 lb.	44,000 lb.	38,104 lb.	31,108 lb.	22,000 lb.
5 in.	27,400 lb.	21,920 lb.	54,800 lb.	47,457 lb.	38,744 lb.	27,400 lb.
6 in.	33,000 lb.	26,400 lb.	66,000 lb.	57,156 lb.	46,662 lb.	33,000 lb.
8 in.	42,300 lb.	33,840 lb.	84,600 lb.	73,264 lb.	59,812 lb.	42,300 lb.
10 in.	52,900 lb.	42,320 lb.	105,800 lb.	91,623 lb.	74,801 lb.	52,900 lb.
12 in.	63,500 lb.	50,800 lb.	127,000 lb.	109,982 lb.	89,789 lb.	63,500 lb.

Notes:

- 1) The rated capacities are based on stuffer weave construction webbing with a minimum certified tensile strength of 9800 pounds per inch of webbing width.
- 2) Rated capacities for Type III and IV slings apply to both tapered and non-tapered eye constructions. Rated capacities for Type V slings are based on non-tapered webbing.
- 3) For Type VI slings, consult the manufacturer for rated capacities.

RATED CAPACITY FOR SYNTHETIC WEB SLINGS

TABLE 8A
SI-Units - Class 7 - 2 Ply Slings
Types I, II, III, IV













Sling Width, Mms	SINGLE LEG			2 LEG OR SINGLE BASKET			
	HITCH TYPES			HORIZONTAL ANGLES			
	Vertical	Choker	Vertical Basket	Vertical	60°	45°	30°
							
25 mm	1,400 kg.	1,120 kg.	2,800 kg.	2,800 kg.	2,425 kg.	1,980 kg.	1,400 kg.
38 mm	2,150 kg.	1,720 kg.	4,300 kg.	4,300 kg.	3,724 kg.	3,040 kg.	2,150 kg.
44 mm	2,450 kg.	1,960 kg.	4,900 kg.	4,900 kg.	4,243 kg.	3,464 kg.	2,450 kg.
51 mm	2,800 kg.	2,240 kg.	5,600 kg.	5,600 kg.	4,850 kg.	3,959 kg.	2,800 kg.
76 mm	4,000 kg.	3,200 kg.	8,000 kg.	8,000 kg.	6,928 kg.	5,656 kg.	4,000 kg.
102 mm	5,000 kg.	4,000 kg.	10,000 kg.	10,000 kg.	8,660 kg.	7,070 kg.	5,000 kg.
127 mm	6,200 kg.	4,960 kg.	12,400 kg.	12,400 kg.	10,738 kg.	8,767 kg.	6,200 kg.
152 mm	7,500 kg.	6,000 kg.	15,000 kg.	15,000 kg.	12,990 kg.	10,605 kg.	7,500 kg.
203 mm	10,325 kg.	8,260 kg.	20,650 kg.	20,650 kg.	17,883 kg.	14,600 kg.	10,325 kg.
254 mm	12,900 kg.	10,320 kg.	25,800 kg.	25,800 kg.	22,343 kg.	18,241 kg.	12,900 kg.
305 mm	15,500 kg.	12,400 kg.	31,000 kg.	31,000 kg.	26,846 kg.	21,917 kg.	15,500 kg.

TABLE 8B
SI-Units - Class 7 - 2 Ply Slings
Type V

Sling Width, Mms	HITCH TYPES			HORIZONTAL ANGLES		
	Endless Vertical	Choker	Vertical Basket	60°	45°	30°
						
25 mm	2,800 kg.	2,240 kg.	5,600 kg.	4,850 kg.	3,959 kg.	2,800 kg.
38 mm	4,250 kg.	3,400 kg.	8,500 kg.	7,361 kg.	6,010 kg.	4,250 kg.
44 mm	4,900 kg.	3,920 kg.	9,800 kg.	8,487 kg.	6,929 kg.	4,900 kg.
51 mm	5,650 kg.	4,520 kg.	11,300 kg.	9,786 kg.	7,989 kg.	5,650 kg.
76 mm	8,000 kg.	6,400 kg.	16,000 kg.	13,856 kg.	11,312 kg.	8,000 kg.
102 mm	10,000 kg.	8,000 kg.	20,000 kg.	17,320 kg.	14,140 kg.	10,000 kg.
127 mm	12,450 kg.	9,960 kg.	24,900 kg.	21,563 kg.	17,604 kg.	12,450 kg.
152 mm	15,000 kg.	12,000 kg.	30,000 kg.	25,980 kg.	21,210 kg.	15,000 kg.
203 mm	19,250 kg.	15,400 kg.	38,500 kg.	33,341 kg.	27,220 kg.	19,250 kg.
254 mm	24,000 kg.	19,200 kg.	48,000 kg.	41,568 kg.	33,936 kg.	24,000 kg.
305 mm	28,850 kg.	23,080 kg.	57,700 kg.	49,968 kg.	40,794 kg.	28,850 kg.

Notes:

- 1) The rated capacities are based on stuffer weave construction webbing with a minimum certified tensile strength of 175 kilograms per millimeter of webbing width.
- 2) Rated capacities for Type III and IV slings apply to both tapered and non-tapered eye constructions. Rated capacities for Type V slings are based on non-tapered webbing.
- 3) For Type VI slings, consult the manufacturer for rated capacities.

RATED CAPACITY FOR SYNTHETIC WEB SLINGS

TABLE 9A
U.S.S. Inch-Pound units - Class 7 - 4 Ply Slings
 Types I, II, III, IV













Sling Width, Inches	SINGLE LEG			2 LEG OR SINGLE BASKET			
	HITCH TYPES			HORIZONTAL ANGLES			
	Vertical	Choker	Vertical Basket	Vertical	60°	45°	30°
							
1 in.	5,500 lb.	4,400 lb.	11,000 lb.	11,000 lb.	9,526 lb.	7,777 lb.	5,500 lb.
2 in.	11,000 lb.	8,800 lb.	22,000 lb.	22,000 lb.	19,052 lb.	15,554 lb.	11,000 lb.
3 in.	16,400 lb.	13,120 lb.	32,800 lb.	32,800 lb.	28,405 lb.	23,190 lb.	16,400 lb.
4 in.	20,400 lb.	16,320 lb.	40,800 lb.	40,800 lb.	35,333 lb.	28,846 lb.	20,400 lb.
5 in.	25,500 lb.	20,400 lb.	51,000 lb.	51,000 lb.	44,166 lb.	36,057 lb.	25,500 lb.
6 in.	30,600 lb.	24,480 lb.	61,200 lb.	61,200 lb.	52,999 lb.	43,268 lb.	30,600 lb.

TABLE 9B
U.S.S. Inch-Pound units - Class 7 - 4 Ply Slings
 Type V

Sling Width, Inches	HITCH TYPES			HORIZONTAL ANGLES		
	Endless Vertical	Choker	Vertical Basket	60°	45°	30°
						
1 in.	11,000 lb.	8,800 lb.	22,000 lb.	19,052 lb.	15,554 lb.	11,000 lb.
2 in.	22,000 lb.	17,600 lb.	44,000 lb.	38,104 lb.	31,108 lb.	22,000 lb.
3 in.	32,900 lb.	26,320 lb.	65,800 lb.	56,983 lb.	46,521 lb.	32,900 lb.
4 in.	40,800 lb.	32,640 lb.	81,600 lb.	70,666 lb.	57,691 lb.	40,800 lb.
5 in.	51,000 lb.	40,800 lb.	102,000 lb.	88,332 lb.	72,114 lb.	51,000 lb.
6 in.	61,200 lb.	48,960 lb.	122,400 lb.	105,998 lb.	86,537 lb.	61,200 lb.

Notes:

- 1) The rated capacities are based on stuffer weave construction webbing with a minimum certified tensile strength of 9800 pounds per inch of webbing width.
- 2) Rated capacities for Type III and IV slings apply to both tapered and non-tapered eye constructions. Rated capacities for Type V slings are based on non-tapered webbing.
- 3) For Type VI slings, consult the manufacturer for rated capacities.

RATED CAPACITY FOR SYNTHETIC WEB SLINGS

TABLE 10A
SI-Units - Class 7 - 4 Ply Slings
 Types I, II, III, IV













Sling Width, Mms	SINGLE LEG			2 LEG OR SINGLE BASKET			
	HITCH TYPES			HORIZONTAL ANGLES			
	Vertical	Choker	Vertical Basket	Vertical	60°	45°	30°
							
25 mm	2,500 kg.	2,000 kg.	5,000 kg.	5,000 kg.	4,330 kg.	3,535 kg.	2,500 kg.
51 mm	5,000 kg.	4,000 kg.	10,000 kg.	10,000 kg.	8,660 kg.	7,070 kg.	5,000 kg.
76 mm	7,450 kg.	5,960 kg.	14,900 kg.	14,900 kg.	12,903 kg.	10,534 kg.	7,450 kg.
102 mm	9,250 kg.	7,400 kg.	18,500 kg.	18,500 kg.	16,021 kg.	13,080 kg.	9,250 kg.
127 mm	11,550 kg.	9,240 kg.	23,100 kg.	23,100 kg.	20,005 kg.	16,332 kg.	11,550 kg.
152 mm	13,900 kg.	11,120 kg.	27,800 kg.	27,800 kg.	24,075 kg.	19,655 kg.	13,900 kg.

TABLE 10B
SI-Units - Class 7 - 4 Ply Slings
 Type V

Sling Width, Mms	HITCH TYPES			HORIZONTAL ANGLES		
	Endless Vertical	Choker	Vertical Basket	60°	45°	30°
						
25 mm	5,000 kg.	4,000 kg.	10,000 kg.	8,660 kg.	7,070 kg.	5,000 kg.
51 mm	10,000 kg.	8,000 kg.	20,000 kg.	17,320 kg.	14,140 kg.	10,000 kg.
76 mm	14,950 kg.	11,960 kg.	29,900 kg.	25,893 kg.	21,139 kg.	14,950 kg.
102 mm	18,525 kg.	14,820 kg.	37,050 kg.	32,085 kg.	26,194 kg.	18,525 kg.
127 mm	21,175 kg.	16,940 kg.	42,350 kg.	36,675 kg.	29,941 kg.	21,175 kg.
152 mm	27,800 kg.	22,240 kg.	55,600 kg.	48,150 kg.	39,309 kg.	27,800 kg.

Notes:

- 1) The rated capacities are based on stuffer weave construction webbing with a minimum certified tensile strength of 175 kilograms per millimeter of webbing width.
- 2) Rated capacities for Type III and IV slings apply to both tapered and non-tapered eye constructions. Rated capacities for Type V slings are based on non-tapered webbing.
- 3) For Type VI slings, consult the manufacturer for rated capacities.

- See Section 1.3 for Basic Sling Types
- Class 5 means slings made from webbing possessing a minimum certified tensile strength of 6800 lbs. per inch of width / 121.43 kilograms per millimeter of width.
- Class 7 means slings made from webbing possessing a minimum certified tensile strength of 9800 lbs. per inch of width / 175 kilograms per millimeter of width.

NOTES:

1. For Type VI Slings - consult the manufacturer for rated capacities.
2. The choker capacity for 1 and 2 ply slings shall be rated at a maximum of 80% of vertical capacity, with an angle of choke of 120 degrees at the point of choke.
3. Slings not included in these tables shall be used in accordance with the manufacturer's recommendations.
4. Rated capacities for type III and IV slings apply to both tapered and non-tapered eye constructions. Rated capacities for type V slings are based on non-tapered webbing. Bunching of both tapered and non-tapered eye/webbing will reduce the rated capacity of the sling.
5. When attaching any hardware to a web sling, a wear pad should be used between the surface of the hardware and the synthetic web sling.
6. All vertical capacities are rounded per the following logic listed below. All subsequent capacities in tables are based on the rounded vertical capacities. No further rounding occurs.

Pounds:	0-49 = 0	Kilograms:	0-24 = 0
	50-99 = 50		25-74 = 25
			75-99 = 75

2.10.6 Rated capacities are affected by angle of lift (sling to load) measured from the horizontal when used with multi-legged slings or choker/basket hitches. To determine the actual sling capacity at a given angle of lift, multiply the original sling rating by the appropriate loss factor determined from the table below.

Sling Angle Table (Angle of Lift)

Angle/Degrees Horizontal	Loss Factor	Angle/Degrees Horizontal	Loss Factor
90	1.000	55	0.819
85	0.996		
80	0.985	45	0.707
75	0.966		
70	0.940		
65	0.906		
60	0.866		

Example: 1 inch, class 7, type 5 endless web sling without fittings, 3200 lbs. vertical rating used in a basket hitch at a 60 degree angle. (See figure 21) (See figure 22 for examples of other angles)

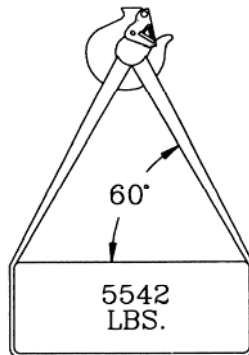

Figure 21

$$\frac{6400 \text{ lbs.} \times 0.866 = 5542 \text{ lbs. Rated Capacity}}{\text{Sling Rating} \times \text{Factor} = \text{Rated Capacity}} \\ \text{Vertical Basket}$$

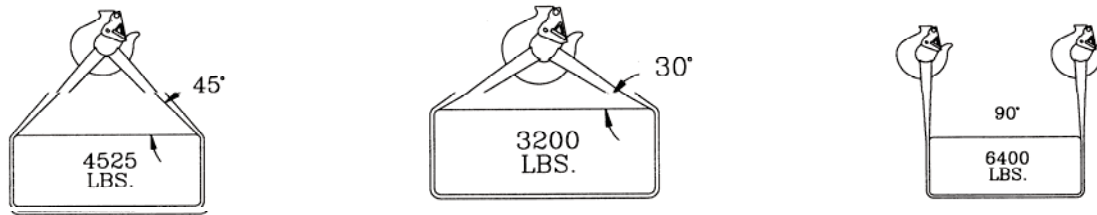
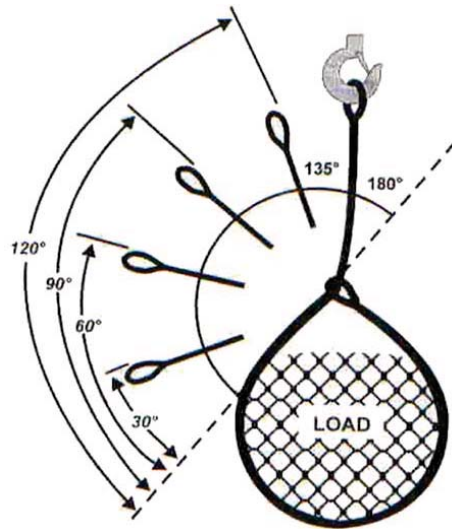

Figure 22



ANGLE of CHOKE

Figure 23

2.10.7 For web slings used in a choker hitch, rated capacities in Tables are for an angle of choke of 120 degrees or greater for the angle formed in the web sling body as it passes through the choking eye. (See table below and figure 23)

RATED CAPACITY of CHOKER HITCH TABLE

Angle of Choke (degrees)	Sling Rated capacity factor as percentage of single leg choker hitch capacity
120-180	100 %
90-120	87 %
60-89	74 %
30-59	62 %
0-29	49 %

2.10.8 Special Considerations for Large Hooks, Shackles, etc.

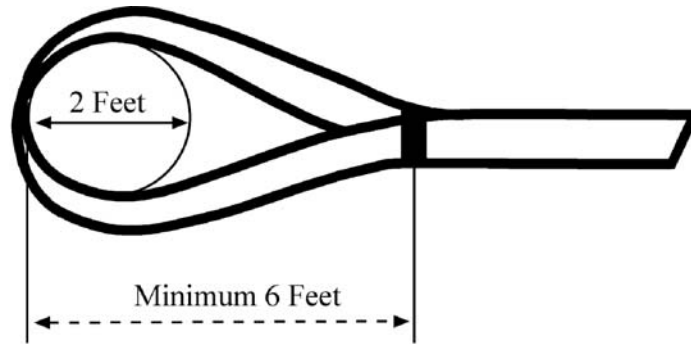

Figure 24

The ratio of the length of a loop eye, to the diameter of the object over which the loop eye is to be placed, should be a minimum three-to-one relationship. EXAMPLE SHOWN is if you have a hook or shackle two feet in diameter. By using this ratio the angle of the two legs of the eye at its throat will not be so severe as to cause a parting or tearing action at this point.

CHAPTER 3.0 STANDARD PROCEDURES for TESTING WEB SLINGS

Section-3.1 PURPOSE

3.1.1 This chapter provides standard procedures for the testing of synthetic web slings.

Section 3.2 TYPES OF TESTS

- 3.2.1 **Destructive Test** - Test of a web sling for the purpose of verifying the rated capacity. The webbing shall be pulled in a vertical hitch until destroyed (broken).
- 3.2.2 **Proof Load Test** - A non-destructive load test of a web sling to some multiple of the rated capacity of the web sling, including fittings if applicable, usually two (2) times the rated capacity .

Section 3.3 TEST CHARACTERISTICS

- 3.3.1 **Sample** - For purposes of verification of rated capacities, the test web sling should be taken from a production lot.
- 3.3.2 **Web Sling Body Length** - The distance between stitch patterns should be a minimum of twice the pattern length.
- 3.3.3 **Loop Eye Length** - The loop eyes should be of sufficient length so that the included angle (θ) formed by the loop eye on the pin is a maximum of 26 degrees. (See figure 25)

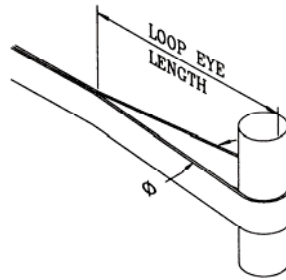

Figure 25

- 3.3.4 Web slings incorporating fittings shall be tested with the fittings attached.
- 3.3.5 **Sling Hitches**
- a. **Hitch/Vertical** - The web sling shall be rigged in the test machine so that tension is applied in a straight-line pull. (See figure 26)

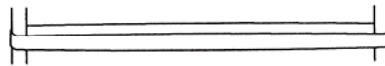

Figure 26

- b. **Hitch/Choker** - The web sling should be rigged in the test machine so that the minimum angle of choke is 120 degrees. (See figure 27)

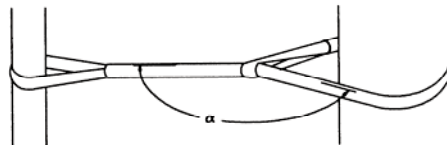

Figure 27

c. Hitch/Basket - The web sling should be rigged in the test machine so that the maximum included angle (θ) of the legs is 60 degrees. (See figure 28)

Caution: Pin size shall accommodate greater load required for basket hitch test.

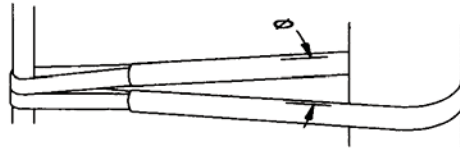

Figure 28

- 3.3.6 Proof testing should be conducted using a pin diameter of 1 inch (25 mm) or larger.
- 3.3.7 The web sling shall not be preloaded prior to testing unless this is part of the manufacturer's normal production process.
- 3.3.8 The test machine shall be certified annually to ASTM E4 or equivalent.

Section 3.4 TEST PROCEDURES OF WEB SLINGS FOR THE VERIFICATION OF RATED CAPACITY

WARNING: THE USE OF IMPROPER TEST PROCEDURES AND/OR MATERIALS MAY RESULT IN SEVERE PERSONAL INJURY OR DEATH.

- 3.4.1 Rated Capacity testing of web slings without fittings shall be tested on the following maximum pin diameters. The pins shall be capable of sustaining the maximum applied load without deformation or failure.

TEST PIN TABLE

Webbing Size	Pin Diameter	Jaw Span
1" - 2" (25 - 51 mm)	2.00" (51 mm)	2.25" (57 mm)
3" - 6" (76 - 152 mm)	3.75" (96 mm)	6.50" (165 mm)
8" - 12" (204 - 304 mm)	4.50" (115 mm)	13.00" (330 mm)

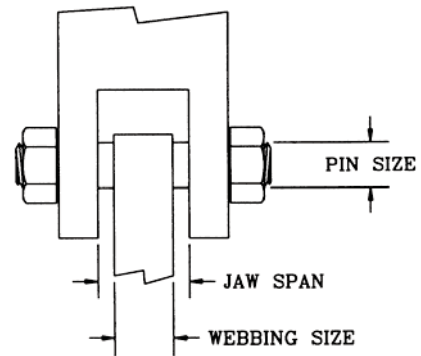

Figure 29

CAUTION: The above pin sizes were used to develop the slings vertical rated capacities. Pin sizes smaller than these may reduce the rated capacity of the sling. These pin sizes may not be adequate for testing slings in a basket configuration.

- 3.4.2 **Atmospheric Conditions** - Synthetic web slings should be tested at ambient temperatures unless otherwise specified. In the case of disputed or conflicting test results, additional tests should be conducted. After the samples have been conditioned for a minimum period of 24 hours in an environment of 70 degrees Fahrenheit +/- 2 degrees and a relative humidity of 65% +/- 2% per Federal Test Method Standard 191A.
- 3.4.3 Web slings with fittings shall be pulled on pins that allow the fittings to be properly seated on the pins.
- 3.4.4 All web slings shall be pulled at a head speed of 4 to 10 inches per minute, or a maximum of 3000 pounds per second / 101.6 millimeters to 254 millimeters per minute or a maximum of 1,361 kilograms per second.
- 3.4.5 Webbing and fitting(s), if applicable, shall be new.
- 3.4.6 The test machine shall be certified annually to ASTM E4 or equivalent.

Section 3.5 CERTIFICATION

- 3.5.1 When certification is required, a certificate shall be issued describing the type, date, and results of test by the company performing the test.

CHAPTER 4.0 IDENTIFICATION MARKERS

Section 4.1 PURPOSE

- 4.1.1 This chapter provides identification of types of fibers, manufacturers of synthetic sling webbing, and manufacturers of web slings.

Section 4.2 IDENTIFICATION OF FIBER TYPES

- 4.2.1 **Identification Marker** - Marker shall be a color sealed or dyed yarn
- 4.2.2 **Location of Marker** - Marker shall be located in the center of the webbing on at least one face.
- 4.2.3 **Codes:**

<u>Fiber</u>	<u>Color Code</u>
<i>Nylon</i>	<i>No Marker</i>
<i>Polyester</i>	<i>Blue Marker</i>

Section 4.3 IDENTIFICATION OF SYNTHETIC SLING WEBBING MANUFACTURERS

- 4.3.1 **Identification Marker** - The webbing manufacturer identification marker shall be a color sealed or dyed yarn.
- 4.3.2 **Location of Marker** - All double and multiple layer weaves shall be identified for manufacturer's color code in accordance with the following options:
 - a. Color code markers located in the binder
 - b. Color code markers located between the surface plies
- 4.3.3 **Codes** - For a listing of manufacturers color-codes and in-depth webbing specifications refer to WSTDA-WB1.

Section 4.4 IDENTIFICATION OF SYNTHETIC WEB SLING MANUFACTURERS

- 4.4.1 **Identification Marker** - The web sling manufacturer identification marker shall be a durable mark which includes the name of the manufacturer.
- 4.4.2 **Location of Marker** - The web sling manufacturer identification marker shall be located inside a splice.

Section 4.5 IDENTIFICATION OF SYNTHETIC WEBBING CLASS

- 4.5.1 Class 5 nylon or polyester webbing shall contain an external black I.D. marker clearly visible and woven in at least one edge to indicate material as class 5 tensile strength.

CHAPTER 5.0 OPERATING PRACTICES FOR WEB SLINGS

Section 5.1 PURPOSE

- 5.1.1 The purpose of this chapter is to provide guidelines for the qualified person responsible for web sling selection, rigging, inspection and use.

Section 5.2 MECHANICAL CONSIDERATIONS

- 5.2.1 Determine weight of the load. The weight of the load shall be within the rated capacity of the web sling.
- 5.2.2 Select a web sling having suitable characteristics for the type of load, hitch and environment.
- 5.2.3 Web slings shall not be loaded in excess of the rated capacity shown on the attached identification tag. Consideration shall be given to the sling to load angle (See figure 22) which affects rated capacity.
- 5.2.4 Web slings with fittings, which are used in a choker hitch, shall be of sufficient length to assure that the choking action is on the webbing, and should not be on the fitting, the base of the eye or fitting, the load carrying splice and the sling tag.

- 5.2.5 Web slings used in a basket hitch should have the load controlled to prevent slippage.
- 5.2.6 The opening in fittings shall be the proper shape and size to ensure that the fitting will seat properly in the hook or other attachments.
- 5.2.7 Web slings shall always be protected from being cut or damaged by corners, edges, protrusions or abrasive surfaces with protection sufficient for the intended purpose.
- 5.2.8 Web slings should not be dragged on the floor or over abrasive surfaces.
- 5.2.9 Web slings shall not be twisted, shortened, lengthened, tied in knots, or joined by knotting. Web slings shall be shortened, lengthened, or adjusted only by methods approved by the manufacturer.
- 5.2.10 Web slings should not be pulled from under loads when the load is resting on the web sling. Loads resting on web slings could damage the sling.
- 5.2.11 Do not drop web slings equipped with metal fittings.
- 5.2.12 Web slings that appear to be damaged shall not be used unless inspected and accepted as usable under Section 5.3, 5.4, and 5.5.
- 5.2.13 The web sling shall be hitched in a manner providing control of the load.
- 5.2.14 Personnel, including portions of the human body, shall be kept from between the sling and the load, and from between the sling and the crane hook or hoist hook.
- 5.2.15 Personnel shall not stand under suspended loads. Personnel should stand clear of suspended loads.
- 5.2.16 Personnel shall not ride the web sling or the load being lifted.
- 5.2.17 Shock loading should be avoided.
- 5.2.18 Twisting and kinking the legs shall be avoided.
- 5.2.19 Load applied to the hook shall be centered in the base of the hook to prevent point loading on the hook.
- 5.2.20 During a lift, with or without the load, personnel shall be alert for possible snagging.
- 5.2.21 The web slings legs should contain or support the load from the sides above the center of gravity when using a basket hitch.
- 5.2.22 Web slings shall be long enough so that the rated capacity (Working Load Limit) is adequate when the sling to load angle is taken into consideration (See 2.10)
- 5.2.23 Only web slings with legible identification tags shall be used.
- 5.2.24 Tags and labels should be kept away from the load, hook and point of choke.

- 5.2.25 Web slings shall not be constricted or bunched between the ears of a clevis or shackle.
- 5.2.26 Place blocks under load prior to setting down the load to allow removal of the web sling, if applicable.
- 5.2.27 Web slings shall not be used as bridles on suspended personnel platforms.

Section 5.3 ENVIRONMENTAL CONSIDERATIONS

5.3.1 Web slings should be stored in a cool, dry and dark place when not in use to prevent loss of strength through exposure to ultra-violet light. Web slings shall not be stored in chemically active environments.

5.3.2 Chemically active environments can affect the strength of synthetic web slings in varying degrees ranging from little to total degradation. The web sling manufacturer or qualified person should be consulted before slings are used in chemically active environments.

5.3.2.1 Acids

5.3.2.1.1 Nylon is subject to degradation in acids, ranging from little to total degradation.

5.3.2.1.2 Polyester is resistant to many acids, but is subject to degradation, ranging from little to moderate in some acids.

5.3.2.1.3 Each application shall be evaluated, taking into consideration the following:

- a. Type of Acid
- b. Exposure Conditions
- c. Concentration
- d. Temperature

5.3.2.2 Alkalis

5.3.2.2.1 Polyester is subject to degradation in alkalis, ranging from little to total degradation.

5.3.2.2.2 Nylon is resistant to many alkalis, but is subject to degradation ranging from little to moderate in some alkalis.

5.3.2.2.3 Each application shall be evaluated, taking into consideration the following:

- a. Type of Alkalis
- b. Exposure Conditions
- c. Concentration
- d. Temperature

5.3.3 Nylon and polyester slings shall not be used in contact with objects or at temperatures in excess of 194° F (90° C) or below 40° F (-40° C).

- 5.3.4 Web slings incorporating aluminum fittings shall not be used where fumes, vapors, sprays, mists or liquids of alkalis and/or acids are present.
- 5.3.5 Environments in which synthetic web slings are continuously exposed to ultra-violet light can affect the strength of synthetic web slings in varying degrees ranging from slight to total degradation.

CAUTION: Degradation can take place without visible indications.

- a. Factors, which affect the degree of strength loss, are:
1. Length of time of continuous exposure
 2. Web sling construction and design
 3. Other environmental factors such as weather conditions and geographic location
- b. Suggested procedures to minimize the affects of sunlight or ultra-violet light.
1. Store web slings in a cool, dry and dark place when not being used for prolonged periods of time.
- c. Some visual indications of sunlight or ultra-violet degradation are:
1. Bleaching out of web sling color
 2. Increased stiffness of web sling material
 3. Surface abrasion in areas not normally in contact with the load
- d. Proof Testing **Warning:** Slings used in environments where they are subject to continuous exposure to sunlight or ultra-violet light shall be proof tested to twice the rated capacity semi-annually, or more frequently depending on severity of exposure.

Section 5.4 INSPECTION

5.4.1 Type of Inspection

- a. **Initial Inspection** - Before any new or repaired web sling is placed in service, it shall be inspected by a designated person to ensure that the correct web sling is being used, as well as to determine that the web sling meets the requirements of this specification.
- b. **Frequent Inspection:** This inspection should be conducted by the person handling the sling each time the sling is used.
- c. **Periodic Inspection** - This inspection shall be conducted by designated personnel. Frequency of inspection should be based on:
1. Frequency of web sling use
 2. Severity of service conditions
 3. Experience gained on the service life of web slings used in similar applications
 4. Inspections should be conducted at least annually

Section 5.5 REMOVAL FROM SERVICE

- 5.5.1 Treated and untreated nylon and polyester webbing, used to fabricate synthetic slings, per class 5 and class 7 rated capacity charts, may contain red yarn woven into the core of the webbing to serve only as one of many aids in determining whether and when a sling should be removed from service.
- 5.5.2 A web sling shall be removed from service if any of the following are visible:
 - a. If sling rated capacity or sling material identification is missing or not readable
 - b. Acid or alkalis burns
 - c. Melting, charring or weld spatters on any part of the web sling
 - d. Holes, tears, cuts, snags or embedded particles
 - e. Broken or worn stitching in load bearing splices
 - f. Excessive abrasive wear
 - g. Knots in any part of the web sling
 - h. Excessive pitting, or corrosion, or cracked, or distorted, or broken fittings.
 - i. Any other visible damage that causes doubt as to the strength of the sling

Section 5.6 INSPECTION RECORDS

- 5.6.1 Written inspection records, utilizing the identification for each sling as established by the user, should be kept on file for all web slings. These records should show a description of the sling and its condition on each periodic inspection.

Section 5.7 REPAIR OF WEB SLINGS

- 5.7.1 Sling webbing with structural damage shall never be repaired. (See 5.5.1)
- 5.7.2 Type I and Type II web slings, and other web slings utilizing hardware, may be re-webbed utilizing existing fittings. It shall be the responsibility of the manufacturer repairing the web sling to determine if the hardware is re-usable.
- 5.7.3 Slings shall be repaired only by a sling manufacturer or a qualified person. When repaired, a sling shall be marked to identify the repair agent.
- 5.7.4 All re-webbed Type I and Type II, and other web slings utilizing fittings, shall be proof tested to two (2) times their vertical rated capacity before being placed back into service. A certificate of proof testing shall be provided.
- 5.7.5 Temporary repairs of webbing, fittings, or stitching shall not be permitted.
- 5.7.6 Repaired slings shall be proof tested to two (2) times its assigned rated capacity before being put back into service.

OTHER WEB SLING & TIE DOWN ASSOCIATION PUBLICATIONS

Recommended Standard Specifications:

Recommended Standard Specifications:

Printed Books

Synthetic Web Slings	WSTDA-WS-1
Synthetic Polyester Roundslings	WSTDA-RS-1
Webbing for Synthetic Web Slings	WSTDA-WB-1
Sewing Threads for Slings & Tie Downs	WSTDA-TH-1
Synthetic Web Tie Downs	WSTDA-T-1
Winches Used With Web Tie Downs	WSTDA-T-3
Synthetic Webbing Used for Tie Downs	WSTDA-T-4
All Standards In A Three-Ring Binder	WSTDA-ASB-2006

PDF Files On CD

Synthetic Web Slings	WSTDA-SCD-WS-1
Synthetic Polyester Roundslings	WSTDA-SCD-RS-1
Webbing for Synthetic Web Slings	WSTDA-SCD-WB-1
Sewing Threads for Slings & Tie Downs	WSTDA-SCD-TH-1
Synthetic Web Tie Downs	WSTDA-SCD-T-1
Winches Used With Web Tie Downs	WSTDA-SCD-T-3
Synthetic Webbing Used for Tie Downs	WSTDA-SCD-T-4
All Standards CD - (All above on one CD)	WSTDA-ASCD-2006

Operating & Inspection Manuals

Synthetic Web Slings	WSTDA-WS-2
Synthetic Web Slings	WSTDA-WS-PS-2 (pocket sized)
Synthetic Polyester Roundslings	WSTDA-RS-2
Synthetic Polyester Roundslings	WSTDA-RS-2-PS (pocket sized)
Synthetic Web Tie Downs	WSTDA-T-2
Synthetic Web Tie Downs	WSTDA-T-2-PS (pocket sized)

Video

Synthetic Web Sling Care & Inspection	WSTDA-WSV-1-VHS
Synthetic Web Sling Care & Inspection	WSTDA-WSV-1-CD

Illustrated Wall Chart

Inspection of Web Slings & Round Slings	WSTDA-WSWC-1
---	--------------

UV Degradation Reports

Summary Report UV Degradation	WSTDA-UV-Sling-2003
UV Degradation Mini Manual	WSTDA-UV-MM-2005
UV Degradation Report	WSTDA-UVDR-1981 (Revised 2005)

Training CD-Rom

North America Cargo Securement Standard	WSTDA-CD-TP-2003
---	------------------

Fabric Warning Labels

Nylon Web Slings	WSTDA-SW-02-N
Polyester Web Slings	WSTDA-SW-02-P
Tie Downs	WSTDA-TW-02
Round Slings	WSTDA-RSW-03

Paper Warning Sheets

Synthetic Web Slings	WSTDA-WSWS-02
Polyester Roundslings	WSTDA-RSWS-04
Tie Downs	WSTDA-TWS-97

For ordering information and prices, contact the association office or visit our website:

Web Sling & Tie Down Association, Inc.

2105 Laurel Bush Road, Suite 200
Bel Air, Maryland 21015
Phone (443) 640-1070
Fax (443) 640-1031
Email: wstda@ksgroup.org
Web Site: www.wstda.com

